

# Instrucciones para hacer avioncitos de papel

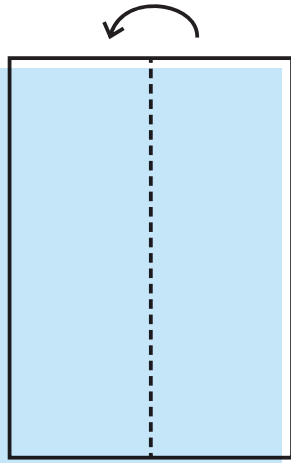

① Dobra el papel por la mitad a lo largo.

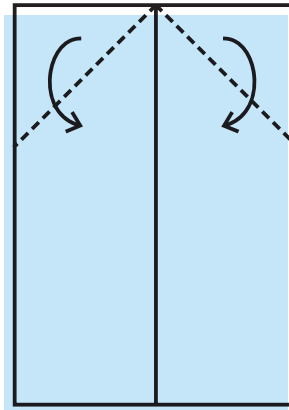

② Dobra para adentro las esquinas superiores.

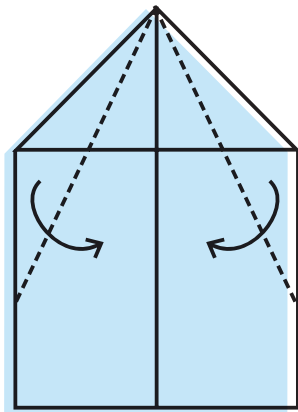
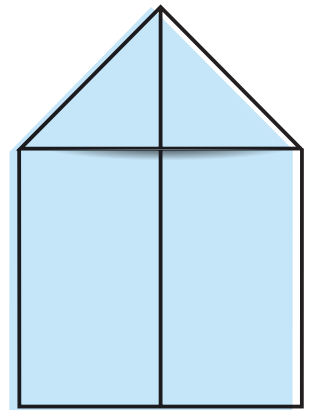

③ Dobra las esquinas ya dobladas hasta el doblar del centro.

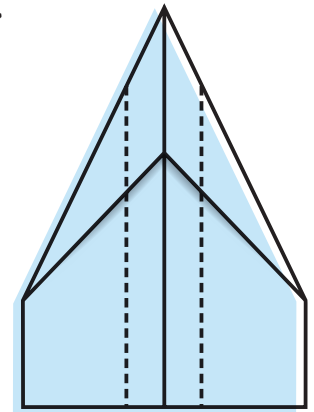
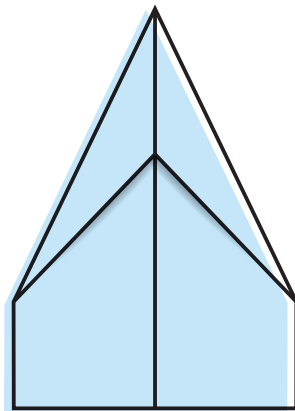

④ Dobra para abajo las alas.

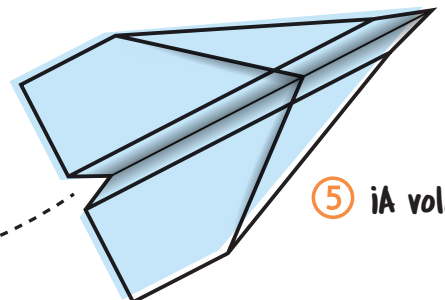

⑤ ¡A volar!